

halfords
SINCE 1892

Mesh Headrest Dog Guard

2 YEAR
GUARANTEE

Fitting Instructions

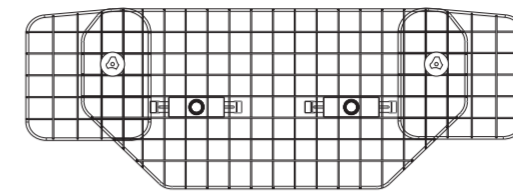

6

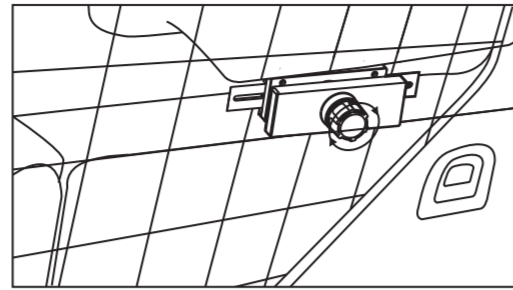

Attach the mesh bracket (D) to the headrest bracket (E). Insert the short plastic screw and turn clockwise to secure. Change the short plastic screw to the long plastic screw (C) if not long enough. Repeat for the second seat.

7

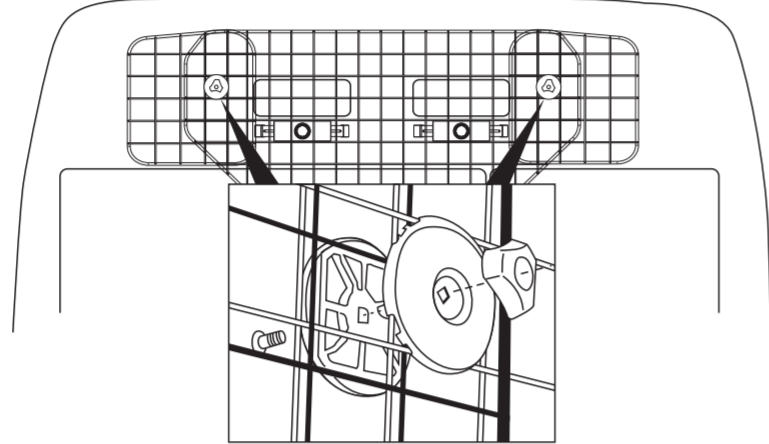

Fasten the extension clips (F) as seen here to attach the small mesh panels (B) to the large mesh panel (A).

Please follow instructions carefully to ensure the safety of you and your passengers. Make sure all parts are included in the package. Please retain these instructions for future reference.

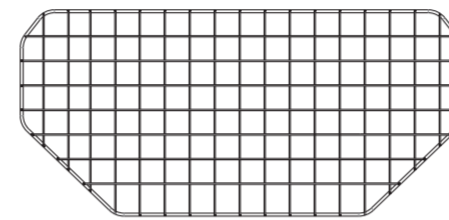

A

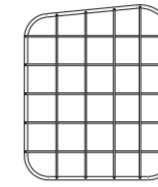

B

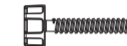

C



(D+E)



F

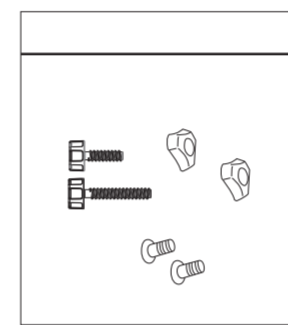

G

CONTENTS

Description	Qty
A Large mesh panel	1
B Small mesh panel	2
C Long plastic screw	2
D Mesh bracket	2
E Headrest bracket	2
F Extension clip	2
G Spare parts bag	1

OUR QUALITY GUARANTEE

This item is covered by our two-year Quality Guarantee. In the unlikely event that it develops a fault within this period, we will replace it. For more details and full conditions, see halfords.com/guarantees or ask in-store.

Images for illustration purposes only.

Halfords Ltd, B98 ODE, Produced for Halfords, www.halfords.com ROI: Halfords c/o DWF, Dublin 1

Item Code: 336630

1

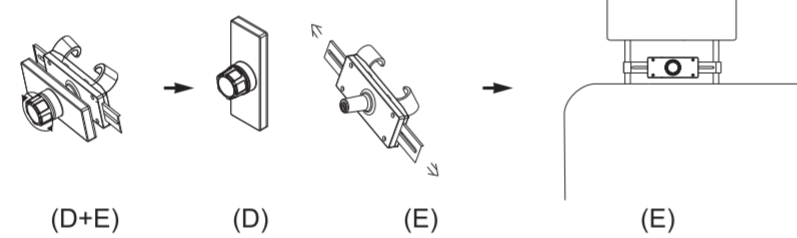

(D+E)

(D)

(E)

(E)

1.1 Separate the mesh bracket (D) from the headrest bracket (E) by turning the screw anti-clockwise.
1.3 Repeat for the second seat.

1.2 Open the headrest bracket (E) to the appropriate size and fit to the seat headrest.

2

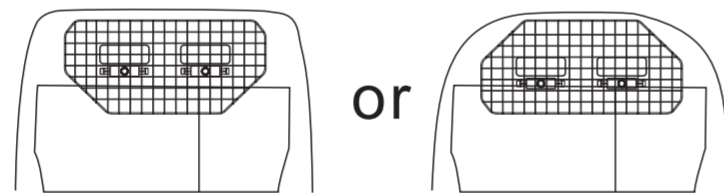

Position the large mesh panel (A) to suit your vehicle (see above).

3

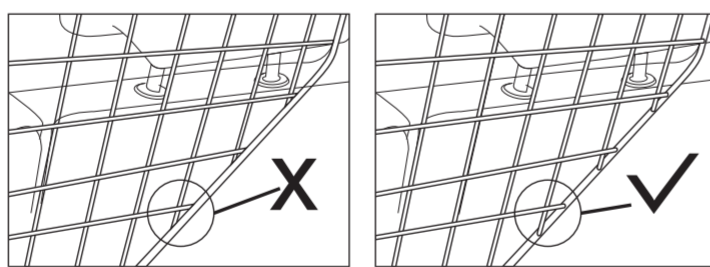

Place the large mesh panel (A) with the outer frame of the mesh facing the front of the vehicle.

4

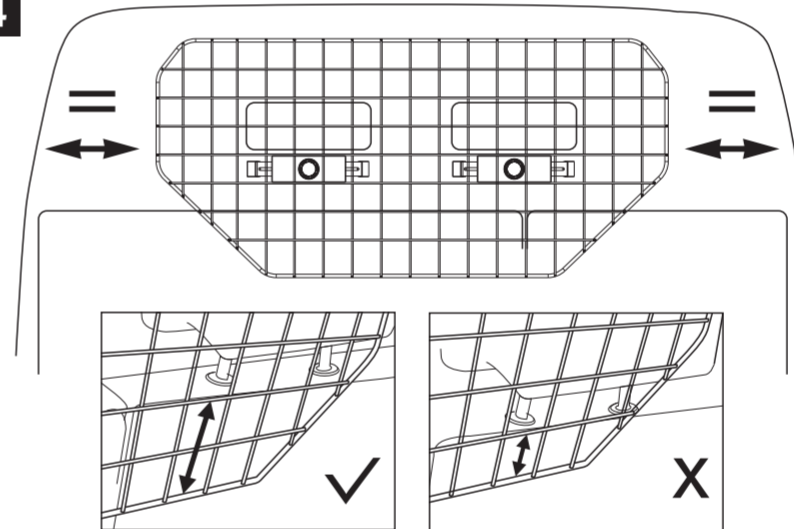

Place the large mesh panel (A) centrally in the vehicle.

5

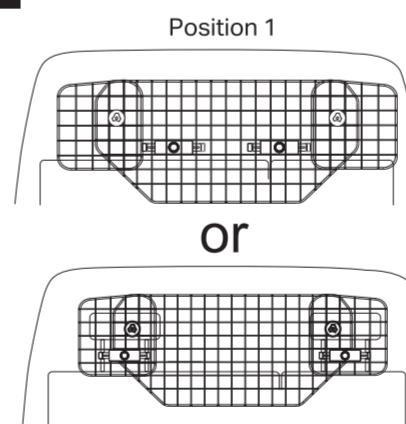

Possible mounting positions

Position 1

Choose the mounting position depending upon the width between the headrests.

or

If using position 2, fit the small mesh panel extensions (step 7) before fixing the guard to the headrests (step 6).

Position 2

General Information

Filename: HAL5625~105317_336630 - Mesh Headrest Guard - Manual
Creation Date: 31.03.22
Project: HAL5625~105317
Brand: Halfords
Description: Mesh Headrest Guard - Manual
Component: Name
Supplier: Name

Barcode Information

Code:
Type:
Magnification:
Height: XX mm
Width Reduction:

Print Information

Print Spec Used: ITG2022
Print Process: Litho
Additional Stations: Not Known
Special Finishes: Not Known

Printed Inks

Process Black

Technical Inks

CUTTER
LEGEND1
LEGEND2

Artworker

Gavin 31.03.22
Daljit 08.04.22

In the absence of a supplied print specification, repro is produced to an ITG generic spec. A copy of this specification will be available upon request from repro@itg.co.uk. ITG do not accept responsibility for print specific errors in the absence of a supplied print specification.

halfords
packaging artwork

Acc Mgr: Aisha Masood
Email: aishamasood@teamitg.com
Mobile: 07834 740791

Prod Mgr: Richard Wakefield
Email: richardwakefield@teamitg.com
Direct: 07899 817418

teamitg

315 Fort Dunlop, Fort Parkway
Birmingham, B24 9FD • teamitg.com

